

## ANALOGUE INPUTS

IN HI and IN LO are differential inputs. They respond only to the voltage between them and not their voltage with respect to the power supply. There is a limit to this however, known as the Common Mode Range (CMR). Any input must be no higher than  $V+ - 0.5V$  and no lower than  $V- + 1.0V$  (or no lower than  $1.0V$  above the  $-5V$  supply (DPM 10S)). If the power supply is floating with respect to the circuit being monitored, leave link 2 between COM and IN LO intact - otherwise this link should be broken for correct operation. If there is any danger that an input may be taken beyond the power supply rails, a series resistor **MUST** be fitted to limit the input current to less than  $100\mu A$ .

## TROUBLESHOOTING

Most measurement problems arise from Common Mode errors (see above).

- Check 1. Inputs to the meter are within the CMR and certainly within the supply range.  
 Check 2. Power the meter with a battery in the "floating" mode and apply a  $100mV$  signal. If the meter works, check the application circuit. If not call the sales office.

## CIRCUIT CONNECTIONS

The DPM 10 can be configured for any of the applications shown below. Interconnections should be made by one of two methods:

- Via the user's conditioning PCB, terminating at the DPM 10 edge connector.
- Bridging across or cutting the appropriate solder pad links provided (see circuit diagram).

### APPLICATIONS

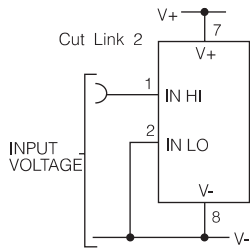

Measuring a single ended input referenced to supply (DPM 10S).

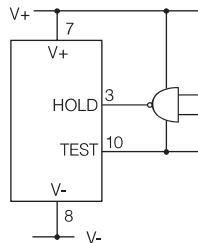

Driving HOLD from external logic.

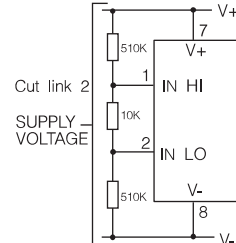

Measuring a supply voltage, min 5V - max 15V (DPM 10).

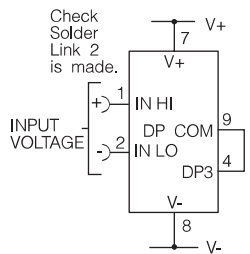

Measuring a floating voltage source of 200mV full scale.

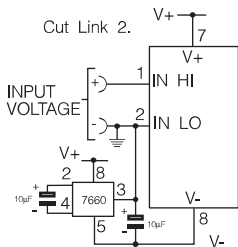

Measuring a single ended input referenced to supply (DPM 10).

Specifications may change without prior warning

DPM 10 ISSUE 4 AUGUST 2002 M.C. (PCB 100)

Lascar Electronics Ltd. Module House, Salisbury, Wiltshire SP5 2SJ, UK; SDC K/MFCN L  
 Lascar Electronics Inc. 3750 West 26th Street, Erie, PA 16506 USA  
 Lascar Electronics (HK) Ltd 7sg Einnq, Bgim @dipnro 'bd Bdmsqd, 032 Gni Atm Qn' c, Kv tm Snmf, Knvinnm, HONG JNMF

Tel: +44 (0)1794 884567 Fax: +44 (0)1794 884616  
 Tel: +1 (814) 835 0621 Fax: +1 (814) 838 8141  
 Tel: +852 2797 3219 Fax: +852 2343 6187



- Low Power
- Digital Hold
- DIN Cutout
- Single Rail Version (DPM 10S)

## 3½ DIGIT LCD DPM 10

A low cost, ultra-low power 3½ digit LCD DPM with a true digital hold of the displayed reading. The panel meter has a DIN compatible bezel, incorporating an integral protective window and is supplied complete with a mounting kit. A 0.1" header provides connection by a variety of methods and the module is easily scaled to measure different voltage.

The DPM 10 features auto-zero, auto-polarity and 200mV F.S.R. (Full Scale Reading). The high contrast display features 12.5mm high digits, programmable decimal points and a low battery annunciator which is automatically displayed. With its high accuracy and simple connections this meter is particularly suited to high volume applications. Options include an extended temperature range and a single rail operating version DPM 10S with built-in negative rail generator enabling the meter to measure a signal referenced to its own power supply.

SPECIFICATIONS	MIN.	TYP.	MAX.	UNIT
Accuracy (overall error) *		0.05	0.1	% ( $\pm 1$ count)
Linearity			$\pm 1$	count
Sample rate		3		per sec
Temperature stability		150		ppm/ $^{\circ}C$
Temperature range	0		50	$^{\circ}C$
Supply voltage (V+ to V-)	Normal	7.5	9	V
	S-Type	3.75	5	
Supply current	Normal	200		$\mu A$
	S-Type	500		
Maximum D.C. input voltage			$\pm 20$	V
Input leakage current ( $V_{in}=0V$ )		1	10	pA
Low battery threshold (Adjustable)	Normal	7		V
	S-type	4		

\* To ensure maximum accuracy, re-calibrate periodically.

### SAFETY

To comply with the Low Voltage Directive (LVD 93/68/EEC), input voltages to the modules pins must not exceed 60Vdc. If voltages to the measuring inputs do exceed 60Vdc, then fit scaling resistors externally to the module. The user must ensure that the incorporation of the DPM into the user's equipment conforms to the relevant sections of BS EN 61010 (Safety Requirements for Electrical Equipment for Measuring, Control and Laboratory Use).

## DIMENSIONS

Dimensions given in mm (inches)

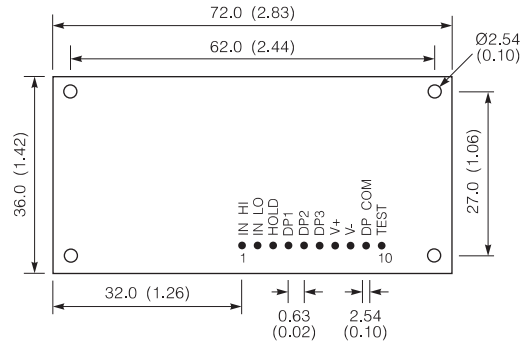
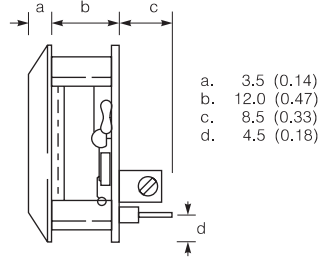
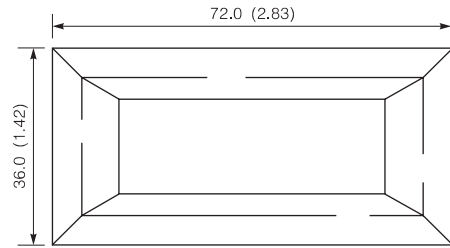

Panel cut-out  
68 x 33 (2.68 x 1.30)

Viewing Area showing display  
in TEST mode.

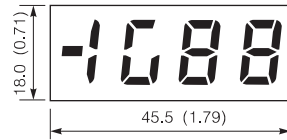

## PIN FUNCTIONS

1. IN HI Positive measuring input.
2. IN LO Negative measuring input.  
Note: Pin is tied by a PCB link to COM. Cut it for any application where the supply voltage is not fully floating. If cut, ensure that the inputs are restricted to the Common Mode Range. COM is held internally at 2.8V below V+ and must not sink excessive current (> 3mA). See "ANALOGUE INPUTS".
3. HOLD If left floating or connected to TEST the meter will continuously display the input voltage. When connected to V+ the last displayed reading will be held indefinitely.
4. DP1 199.9
5. DP2 19.99
6. DP3 1.999
7. V+ Positive power supply.
8. V- Negative power supply.
9. DP COM Connect to pins 4, 5 or 6 (or link PCB pads DP1, 2, 3) to display required decimal point.
10. TEST The ground for internal meter logic, held at 5V (nom.) below V+. Connect to V+ to turn on segments as illustrated. However, it must ONLY be used for short periods as DC is used to drive the LCD and may cause damage. TEST pin may be used as a ground supply for external logic up to 1mA (see APPLICATION DIAGRAMS).  
Outputs for auto-ranging applications. These are solder connections only.

A - J

## CIRCUIT DIAGRAM

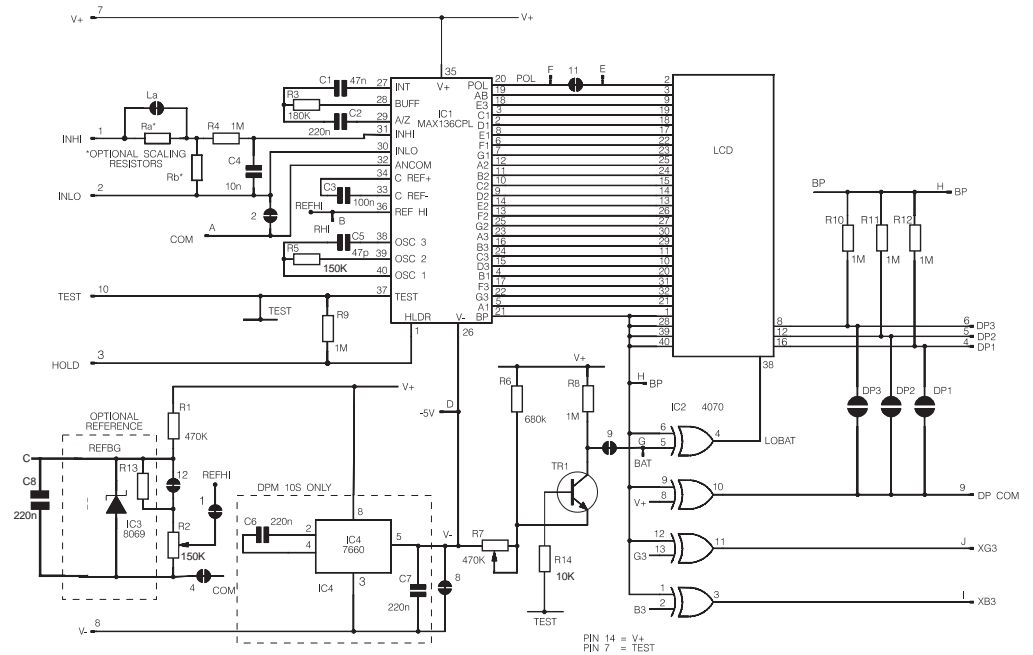

## COMPONENT LAYOUT - Front View with LCD Removed

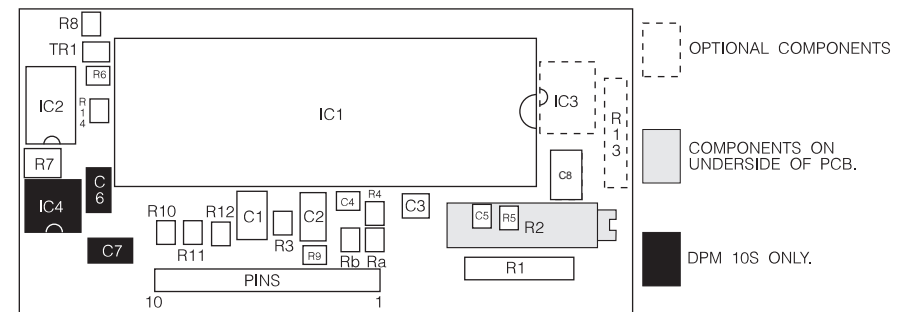

## APPLICATIONS

Input Scaling: Two resistors Ra and Rb may be fitted in order to alter the full scale reading (FSR) of the meter - See Table. The meter will have to be re-calibrated.

## NOTE

Ensure link across Ra is cut.

REQUIRED F.S.R	Ra	Rb
2V	Note	910k
20V	Note	1M
200V	Note	1M
2kV	Note	1M
200µA	0R	1K
2mA	0R	100R
20mA	0R	10R
200mA	0R	1R